

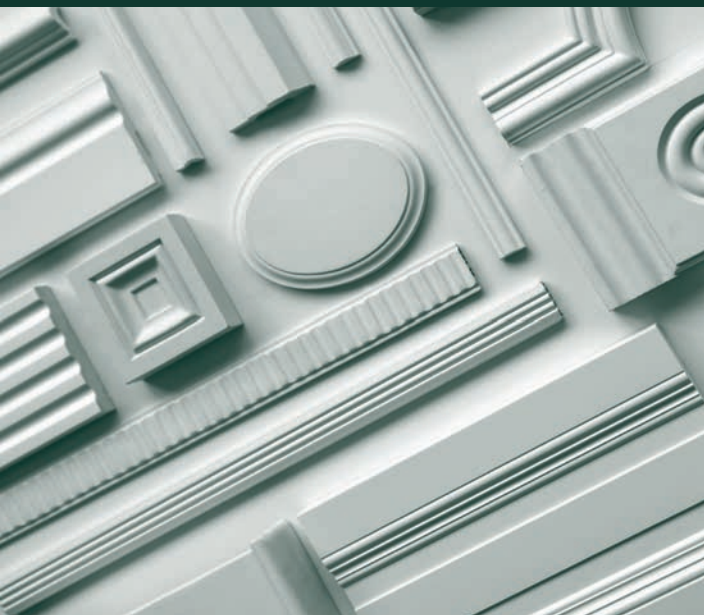

 *Fabello Decor*®

ЛЕПНОЙ ДЕКОР ИЗ ПОЛИУРЕТАНА 01'2020



ЛЕПНОЙ ДЕКОР

Из полиуретана изготавливают карнизы, молдинги, плинтусы, угловые элементы, потолочные розетки, фронтоны, консоли, колонны, полуколонны, пилястры.

С их помощью можно решать различные декоративные задачи. С помощью горизонтальных линий помещение можно сделать шире, с помощью вертикальных – увеличить высоту потолка.

В плинтусы, потолочные карнизы и отдельные настенные элементы встраиваются светодиоды определенного цвета, создающие интересную игру света.

ШИРОКИЙ АССОРТИМЕНТ

Коллекция многообразна и соответствует представлениям о красоте. Богатство ассортимента позволяет решить проблему подбора элементов для любого интерьера.

В коллекции Fabello Decog представлены элементы всех архитектурных стилей, в которых находит применение лепной декор. Элементы декора изготовлены из современного материала – полиуретана.

ПРЕИМУЩЕСТВА

- богатство ассортимента
- стилевое многообразие
- художественная достоверность
- экологическая чистота продукции
- высокий уровень качества, выгодная цена и уникальный дизайн
- долговечность изделий
- быстрый, легкий и чистый монтаж
- возможности для окрашивания
- наличие гибких элементов
- наличие элементов из стекловолокна

Прочный, экологически чистый, легкий полиуретан делает лепной декор максимально приспособленным для украшения интерьера любой сложности. Лепнина не желтеет со временем, не осыпается, не растрескивается, не теряет четкости рельефа, не собирает пыль. Ее можно подвергать влажной уборке. В отличие от мягкого полистирола, который также используется в производстве лепных украшений, она при любых условиях сохраняет форму.

Современный дизайн избегает однообразия, пусть даже классического. Традиционно белые лепные украшения сегодня все чаще подвергаются той или иной покраске. Благодаря специальной грунтовке, поверхность декора Fabello Decog изначально подготовлена к ней. Для этой цели можно использовать любые водоэмульсионные, акриловые, масляные краски. Коллекция Fabello Decog включает в себя весь спектр декоративной лепнины, необходимый для воплощения законченного и гармоничного замысла.

Это богатейший набор карнизов для оформления стыков стен и потолка, молдинги для украшения стен и потолка, розетки, оформляющие пространство вокруг люстры, пилястры, колонны, пьедесталы, а также множество других декоративных элементов, чья уместность в интерьере проверена временем.

С помощью лепного декора Fabello Decog можно воссоздать любую, историческую эпоху в отдельно взятом пространстве или сконструировать собственный новомодный стиль в духе современного эклектизма. Магическому очарованию классических форм найдется место в любой обстановке.





Карнизы с гладким профилем



Карнизы с орнаментом



Молдинги с гладким профилем

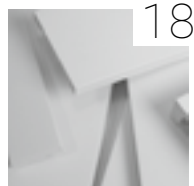

Молдинги-плинтусы



Молдинги с орнаментом



Круговые бордюры



Угловые элементы



Дверные бордюры



Розетки потолочные

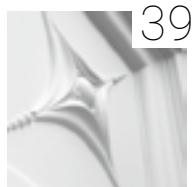

Кессоны



Пилястры



Колонны



Пьедесталы



Ниши



Купола

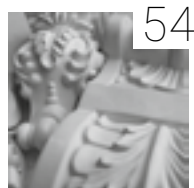

Консоли



Орнаменты

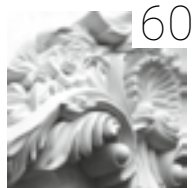

Настенные панно

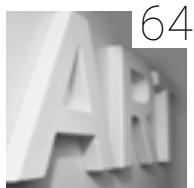

ART

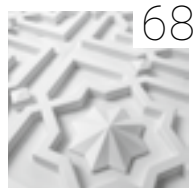

ARXAT

УСЛОВНЫЕ ОБОЗНАЧЕНИЯ

F — имеется гибкий аналог

○ — изделие из стекловолокна

◇ — шторный карниз

● — используется как плинтус

LED — для встроенной подсветки



КАРНИЗЫ

Выступающие элементы внутренней и внешней отделки зданий, помещений, мебели. В архитектуре карниз отделяет плоскость крыши от вертикальной плоскости стены. Карниз из полиуретана — декоративный элемент, соединяющий шов между потолком и стенами.

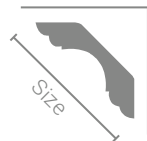

Size — длина поверхности
L — длина изделия



P 2012 Ⓕ
2000x25x27 mm

Size:
34 mm

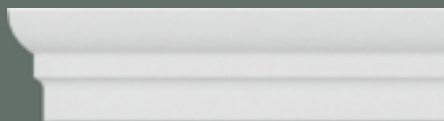

P 892
2000x25x15 mm

Size:
29 mm

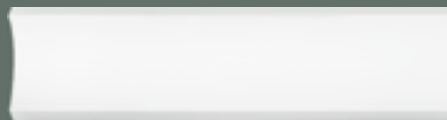

P 2119 Ⓕ ●
2000x30x20 mm

Size:
36 mm



P 2003 Ⓕ
2000x40x40 mm

Size:
57 mm



P 2010 Ⓕ
2000x40x38 mm

Size:
56 mm



P 224 Ⓕ
2000x40x40 mm

Size:
57 mm



P 2057 Ⓕ
2000x45x85 mm

Size:
96 mm



P 221 Ⓕ
2000x50x70 mm

Size:
86 mm



P 222 Ⓕ
2000x50x48 mm

Size:
70 mm

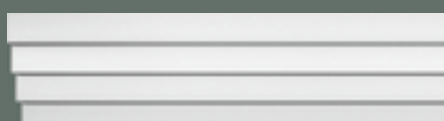

P 886 Ⓕ
2000x50x190 mm

Size:
197 mm





P 2007 Ⓢ
2000x51x51 mm

Size:
72 mm



P 220 Ⓢ
2000x51x60 mm

Size:
78 mm



P 210 Ⓢ
2000x53x50 mm

Size:
73 mm



P 212 Ⓢ
2000x54x50 mm

Size:
74 mm

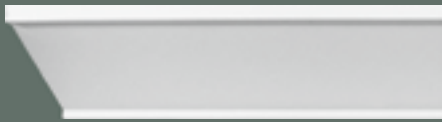

LED
P 881 Ⓢ
2000x55x85 mm

Size:
103 mm



P 205 Ⓢ
2000x57x53 mm

Size:
79 mm

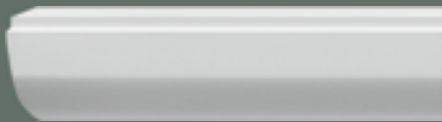

LED
P 883 Ⓢ
2000x60x125 mm

Size:
139 mm



P 209 Ⓢ
2000x64x60 mm

Size:
89 mm



P 214 Ⓢ
2000x67x63 mm

Size:
91 mm



P 134 Ⓢ
2000x66x58 mm

Size:
88 mm





P 219 Ⓢ

2000x68x68 mm

Size:

96 mm

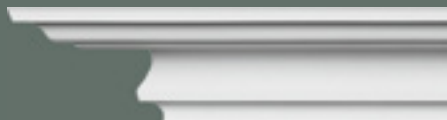

P 2056 Ⓢ

2000x68x100 mm

Size:

121 mm



P 207 Ⓢ

2000x73x68 mm

Size:

100 mm

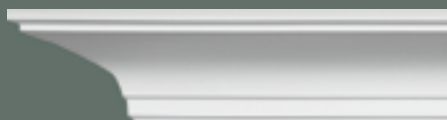

P 136 Ⓢ

2000x58x124 mm

Size:

137 mm



P 232 Ⓢ

2000x78x114 mm

Size:

138 mm



P 208 Ⓢ

2000x68x68 mm

Size:

96 mm

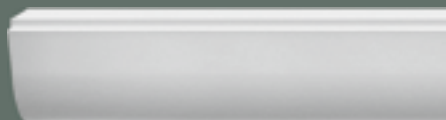

LED

P 882 Ⓢ

2000x70x170 mm

Size:

184 mm



P 201 Ⓢ

2000x74x74 mm

Size:

104 mm



P 203 Ⓢ

2000x75x76 mm

Size:

107 mm



P 887 Ⓢ

2000x80x80 mm

Size:

113 mm





P 2001 
2000x80x80 mm

Size:
118 mm



P 2076 
2000x80x85 mm

Size:
117 mm



P 135 
2000x83x83 mm

Size:
116 mm

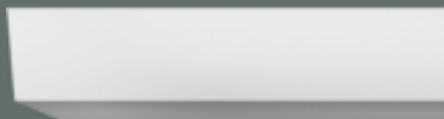

LED
P 885 
2000x83x130 mm

Size:
154 mm



P 2005 
2000x85x115 mm

Size:
143 mm



P 2008 
2000x87x87 mm

Size:
122 mm

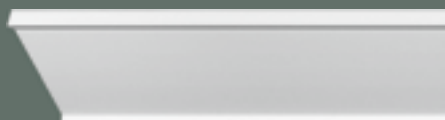

LED
P 884 
2000x90x140 mm

Size:
161 mm

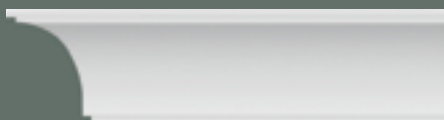
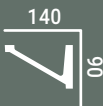

P 893
2000x90x65 mm

Size:
111 mm



P 2055 
2000x91x91 mm

Size:
129 mm



P 2016 
2000x94x90 mm

Size:
131 mm





P 2048 Ⓢ

2000x95x65 mm

Size:
115 mm

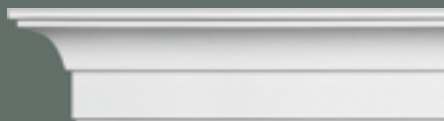

P 2072 Ⓢ

2000x97x63 mm

Size:
116 mm



P 202 Ⓢ

2000x100x98 mm

Size:
140 mm



P 223 Ⓢ

2000x100x100 mm

Size:
141 mm



P 133 Ⓢ

2000x102x155 mm

Size:
186 mm



P 2032 Ⓢ

2000x110x90 mm

Size:
142 mm



P 132

2000x110x230 mm

Size:
255 mm



P 2004 Ⓢ

2000x112x142 mm

Size:
183 mm



P 2006 Ⓢ

2000x130x104 mm

Size:
167 mm





P 2011 Ⓢ

2000x140x137 mm

Size:
195 mm

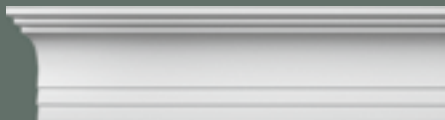



P 880  Size: 2000x170x120 mm
208 mm

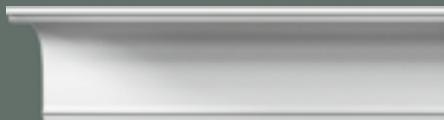
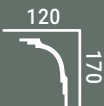

P 888  Size: 2000x180x140 mm
228 mm



P 2024 Size: 2000x183x151 mm
236 mm



P 2031 Size: 2000x288x230 mm
369 mm

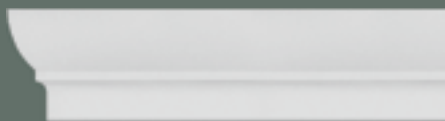

P 889  Size: 2000x100x50 mm
112 mm

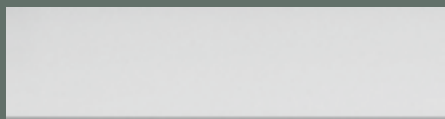
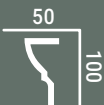

P 890   Size: 2000x110x40 mm
117 mm

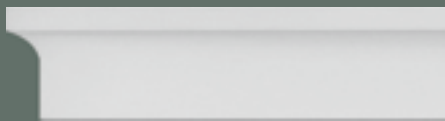

P 891  Size: 2000x130x50 mm
139 mm

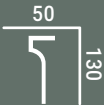

КОМБИНАЦІЯ КАРНИЗОВ



P 149 • C 1093

P 149 • C 1093

C 156 • C 1091



P 149 • C 1093

C 150 • C 1092

C 156 • C 1091



P 149

2000x175x175 mm

Size:
248 mm



C 1093 ®

2000x120x120 mm

Size:
171 mm

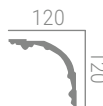

C 150

2000x175x175 mm

Size:
248 mm

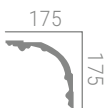

C 1092

2000x120x120 mm

Size:
171 mm

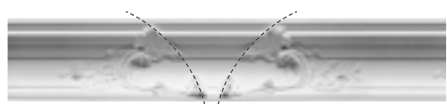
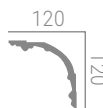

один карниз на два угла

C 156

2000x175x175 mm

Size:
248 mm

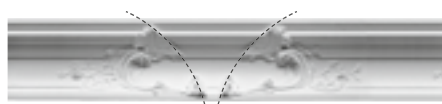
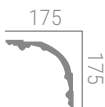

один карниз на два угла

C 1091

2000x120x120 mm

Size:
171 mm

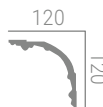

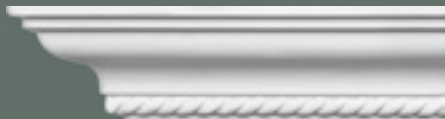

C 1090 [®]
2000x55x56 mm

Size:
78 mm



C 161 [®]
2000x56x56 mm

Size:
79 mm



C 1085
2000x60x60 mm

Size:
87 mm



C 147
2000x64x30 mm

Size:
71 mm



C 1003 [®]
2000x67x41 mm

Size:
78 mm



C 1008
2000x70x55 mm

Size:
89 mm



C 173 [®]
2000x70x75 mm

Size:
101 mm



C 176 [®]
2000x74x72 mm

Size:
103 mm



C 141
2000x75x35 mm

Size:
83 mm



C 128
2000x77x43 mm

Size:
89 mm





C 144 Ⓢ
2000x78x103 mm
Size: 129 mm



C 1001 Ⓢ
2000x79x52 mm
Size: 94 mm



C 160 Ⓢ
2000x80x54 mm
Size: 97 mm



C 1007 Ⓢ
2000x80x61 mm
Size: 100 mm



C 1010 Ⓢ
2000x81x60 mm
Size: 101 mm



C 1009
2000x82x58 mm
Size: 100 mm



C 1030
2000x82x110 mm
Size: 137 mm



C 1013 Ⓢ
2000x84x34 mm
Size: 90 mm



C 138
2000x85x85 mm
Size: 119 mm



C 1004 Ⓢ
2000x86x50 mm
Size: 99 mm





C 177
2000x90x90 mm Size: 126 mm



C 104 Ⓢ
2000x92x92 mm Size: 130 mm



C 1097
2000x100x90 mm Size: 135 mm

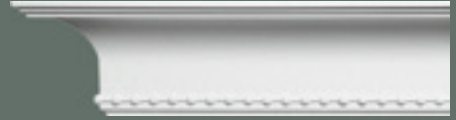

C 1071 Ⓢ
2000x100x70 mm Size: 122 mm



C 1088 Ⓢ
2000x100x60 mm Size: 117 mm



C 1015 Ⓢ
2000x104x57 mm Size: 119 mm



C 1035
2000x108x62 mm Size: 125 mm

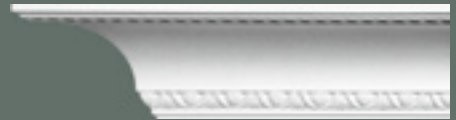

C 122 Ⓢ
2000x108x137 mm Size: 175 mm



C 124
2000x114x54 mm Size: 126 mm



C 125
2000x115x110 mm Size: 159 mm





C 233

2000x116x88 mm

Size:
146 mm



C 158

2000x120x110 mm

Size:
163 mm



C 121 Ⓢ

2000x121x70 mm

Size:
140 mm



C 143

2000x125x125 mm

Size:
176 mm

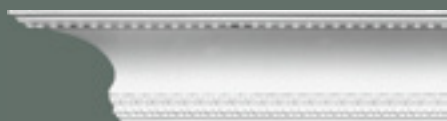

C 109

2000x126x126 mm

Size:
179 mm

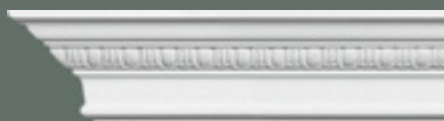

C 123 Ⓢ

2000x126x80 mm

Size:
149 mm



C 204

2000x130x120 mm

Size:
176 mm



C 1012 Ⓢ

2000x140x70 mm

Size:
156 mm



C 159

2000x142x124 mm

Size:
187 mm



C 1049

2000x142x84 mm

Size:
165 mm





C 126 Ⓢ

2000x144x62 mm

Size:

157 mm



C 140 Ⓢ

2000x148x60 mm

Size:

164 mm



C 1061

2000x170x144 mm

Size:

223 mm



C 127

2000x174x140 mm

Size:

223 mm



C 110

2000x180x124 mm

Size:

218 mm



C 102

2000x202x147 mm

Size:

252 mm



C 101

2000x210x114 mm

Size:

238 mm

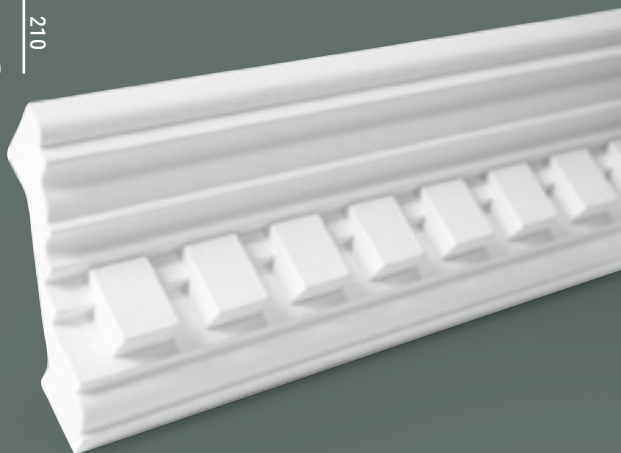



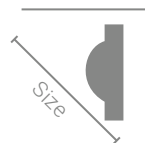

МОЛДИНГИ

Используется для декорирования различных поверхностей: стен, потолка, дверей, каминов и др. Могут использоваться в качестве рам для зеркал, для зонирования поверхности: разбивки на отдельные секции различной формы (прямоугольные, квадратные, фигурные, круглые).



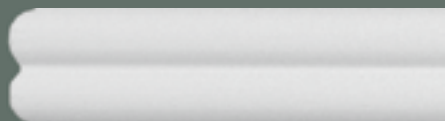

Size — длина поверхности
L — длина изделия

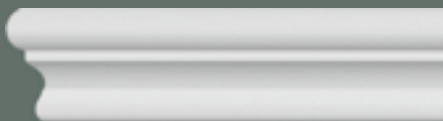

CR 3003 
2000x20x8 mm

Size:
20 mm



CR 3035 
2000x22x12 mm

Size:
22 mm

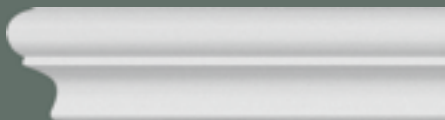

CR 3034 
2000x23x13 mm

Size:
28 mm

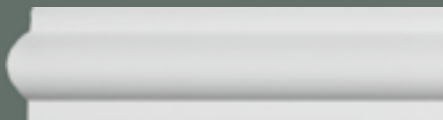

CR 3075 
2000x25x11 mm

Size:
25 mm

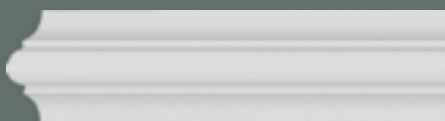

CR 3227 
2000x25x14 mm

Size:
25 mm

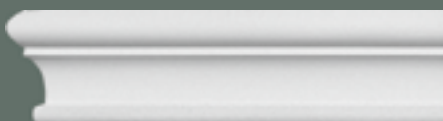

CR 3063 
2000x34x15 mm

Size:
34 mm

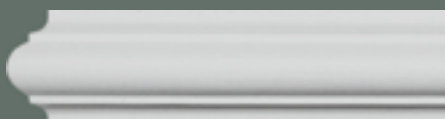

CR 610 
2000x40x18 mm

Size:
40 mm



CR 624 
2000x42x18 mm

Size:
42 mm



CR 518 
2000x43x20 mm

Size:
43 mm



CR 3025 
2000x48x27 mm

Size:
48 mm





CR 3073 
2000x49x20 mm

Size:
49 mm

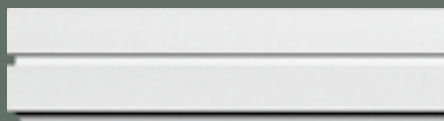
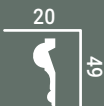

CR 3072 
2000x50x10 mm

Size:
50 mm



CR 3002 
2000x51x6 mm

Size:
51 mm

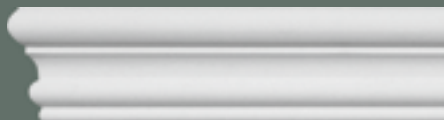

CR 3007 
2000x54x15 mm

Size:
54 mm

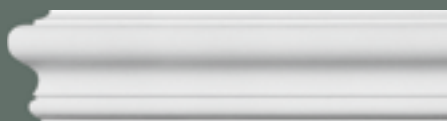

CR 689 
2000x62x26 mm

Size:
62 mm



CR 3006 
2000x68x23 mm

Size:
68 mm

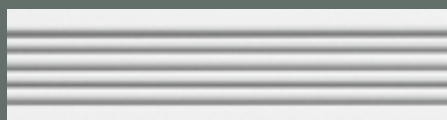

CR 3079 
2000x76x20 mm

Size:
76 mm

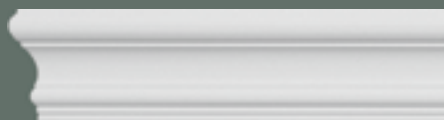
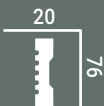

CR 516 
2000x82x22 mm

Size:
82 mm



CR 3001 
2000x101x6 mm

Size:
101 mm



CR 512 
2000x103x41 mm

Size:
103 mm



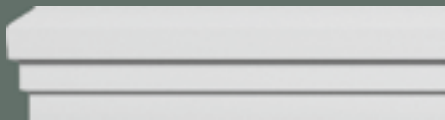

CR 639 (F) ●
2000x75x21 mm

Size:
75 mm

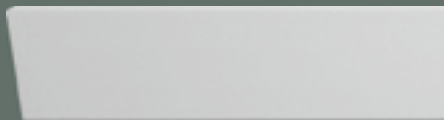

CR 199 (F) ●
2000x80x28 mm

Size:
80 mm

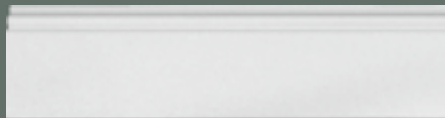

CR 3243 (F) ●
2000x80x12 mm

Size:
80 mm

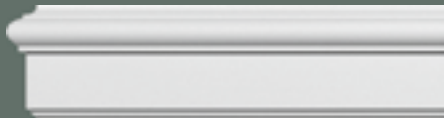
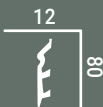

CR 3044 (F) ●
2000x94x33 mm

Size:
94 mm

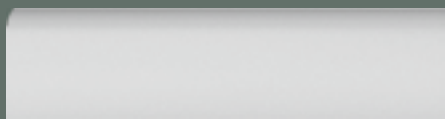

CR 3242 (F) ●
2000x100x20 mm

Size:
100 mm

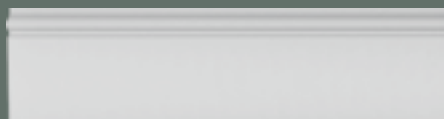

CR 3241 (F) ●
2000x120x15 mm

Size:
120 mm

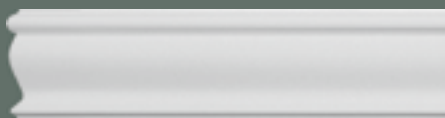

CR 3043 (F) ●
2000x124x26 mm

Size:
124 mm

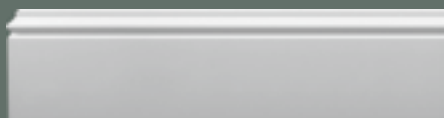

CR 3245 (F) ●
2000x140x18 mm

Size:
141 mm

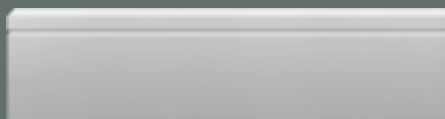

CR 3246 (F) ●
2000x160x16 mm

Size:
160 mm

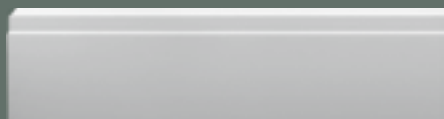
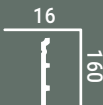

CR 3247 (F) ●
2000x175x18 mm

Size:
176 mm

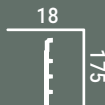



CR 3054 ©
2000x15x5 mm

Size:
15 mm



CR 3100 ©
2000x17x8 mm

Size:
17 mm



CR 407 ©
2000x30x14 mm

Size:
30 mm

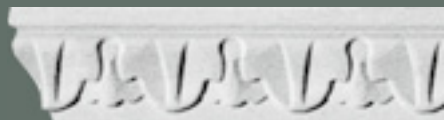

CR 685 ©
2000x32x13 mm

Size:
32 mm

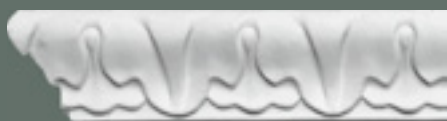

CR 686 ©
2000x35x24 mm

Size:
35 mm



CR 3010
2000x40x25 mm

Size:
40 mm



CR 607 ©
2000x41x23 mm

Size:
41 mm



CR 605 ©
2000x50x25 mm

Size:
50 mm



CR 620 ©
2000x50x25 mm

Size:
50 mm

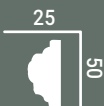

CR 681 ©
2000x50x6 mm

Size:
50 mm

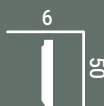



CR 3022

2000x55x6 mm

Size:
55 mm



CR 3023

2000x55x8 mm

Size:
55 mm

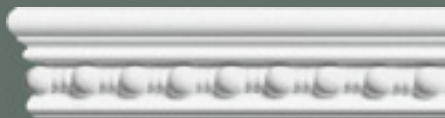

CR 405 Ⓢ

2000x55x21 mm

Size:
55 mm

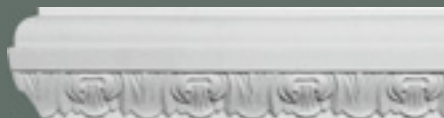

CR 601

2000x55x20 mm

Size:
55 mm



CR 3057

2000x57x9 mm

Size:
57 mm



CR 642

2000x61x33 mm

Size:
61 mm



CR 622

2000x65x30 mm

Size:
65 mm



CR 688 Ⓢ

2000x65x10 mm

Size:
65 mm



CR 3059

2000x68x7 mm

Size:
68 mm



CR 402 Ⓢ

2000x69x21 mm

Size:
69 mm





CR 602 ©

2000x77x19 mm

Size:

77 mm

19

77



CR 153

2000x81x23 mm

Size:

81 mm

23

81



CR 155

2000x81x24 mm

Size:

81 mm

24

81



CR 638

2000x81x22 mm

Size:

81 mm

22

81



CR 636 ©

2000x82x27 mm

Size:

82 mm

27

82



CR 403 ©

2000x88x28 mm

Size:

88 mm

28

88



CR 3051 ©

2000x90x14 mm

Size:

90 mm

14

90



CR 137 ©

2000x106x36 mm

Size:

106 mm

36

106



CR 632 ©

2000x110x20 mm

Size:

110 mm

20

110



CR 646 ©

2000x126x14 mm

Size:

126 mm

14

126



CR 608 ©

2000x138x40 mm

Size:

138 mm

40

138



CR 694

2000x145x45 mm

Size:

152 mm

45

145



CR 3017

2420x192x45 mm

Size:

192 mm

45

192

Используя молдинги или карнизы с легкостью можно изготовить раму для картины или зеркала

CR 608



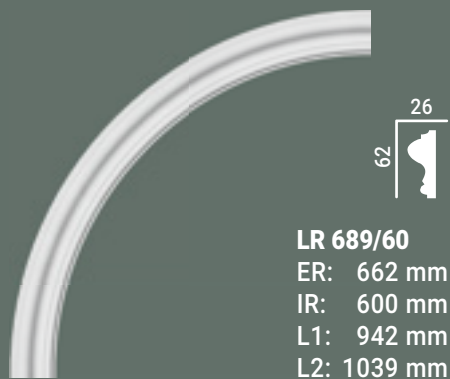
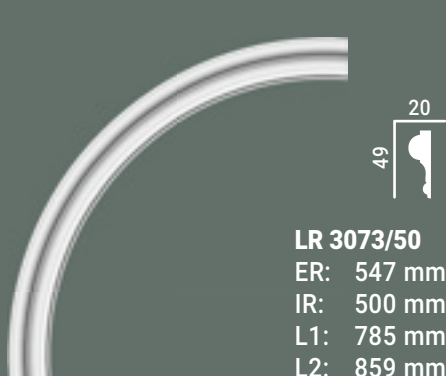
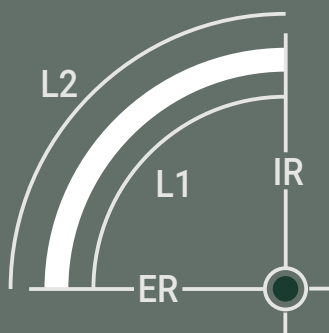



УГЛОВЫЕ ЭЛЕМЕНТЫ

Угловые элементы обычно используют для оформления плоскости потолка или стен определенным рельефом или узором. Лучшие образцы архитектуры элементов декора от древнегреческой классики до модерна используются для придания интерьерам насыщенной и завершенной композиции.

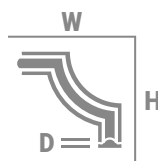

W — ширина
H — высота
D — толщина

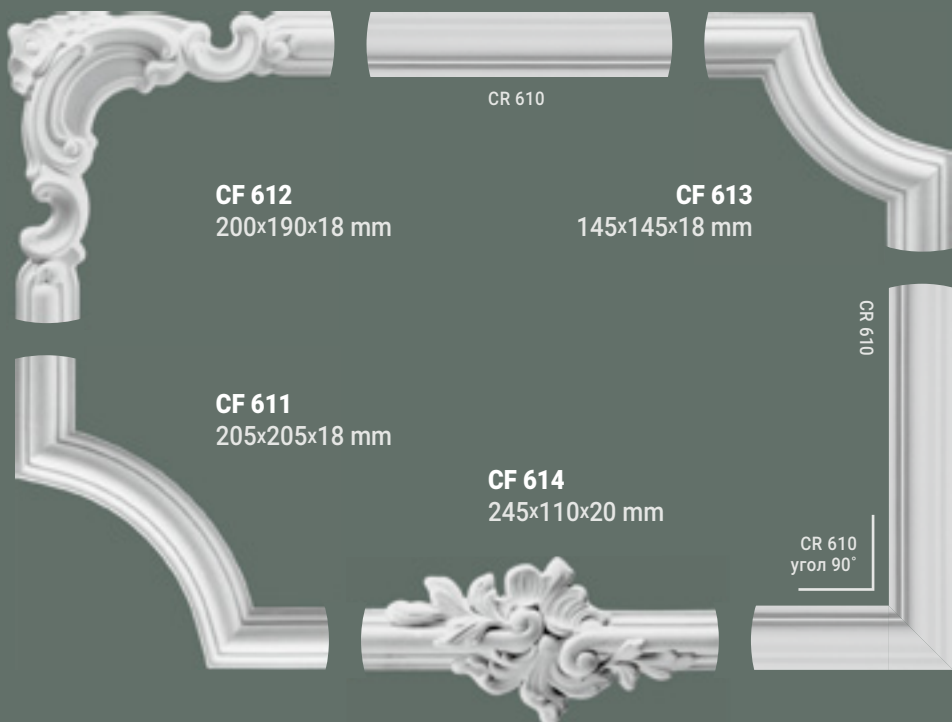
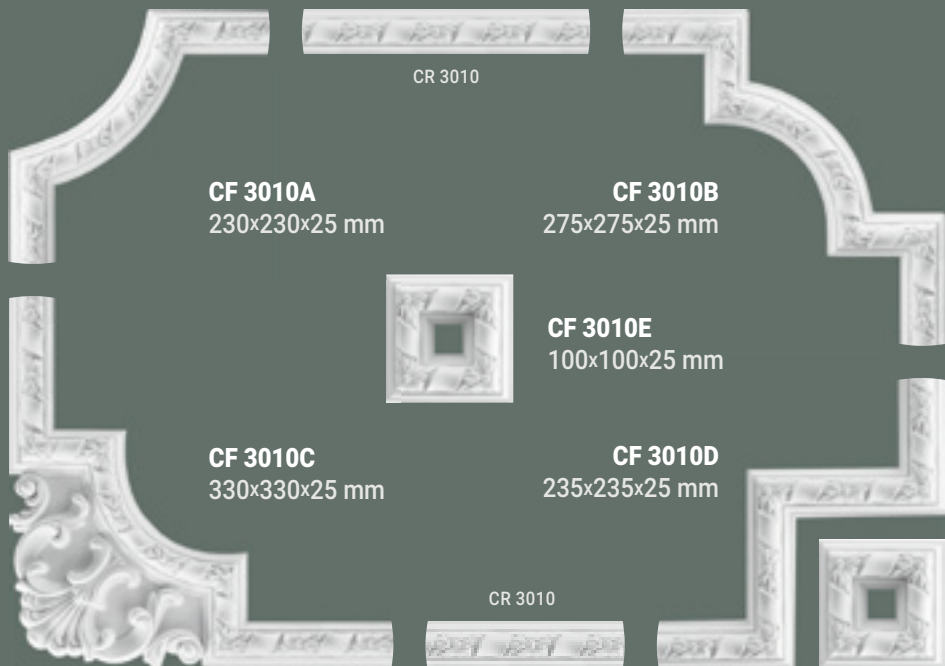



CF 3007A
300x300x35 mm



CR 3007
угол 90°



CF 3007B
295x295x20 mm



CF 3063A
220x220x23 mm



CR 3063
угол 90°



CF 3063B
180x180x15 mm



CF 624A
145x145x20 mm



CR 624
угол 90°



CF 624B
230x230x18 mm



CF 3227A
130x130x14 mm



CR 3227
угол 90°



CF 3227B
80x80x14 mm



CR 518
угол 90°



CF 518B
300x300x28 mm



CR 605
угол 90°



CF 605B
350x290x25 mm



CR 602
угол 90°



CF 602A
385x385x30 mm



CR 607
угол 90°



CF 620A
320x313x25 mm

CR 620
угол 90°





ДВЕРНЫЕ БОРДЮРЫ

Данные украшения используются как обрамление дверных проемов. Это придает дверям классическое изящество. Лепные украшения предоставляют гибкость в подборе и комбинировании желаемых предпочтений. Они также используются для подчеркивания рельефа двери.



D 592
250x95x30 mm



D 590
95x95x40 mm



D 581
195x1250x31 mm



D 588
95x95x50 mm

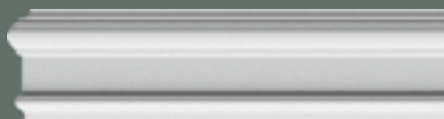

D 580 ©
2000x94x31 mm



D 602
230x109x28 mm



D 601
90x90x26 mm

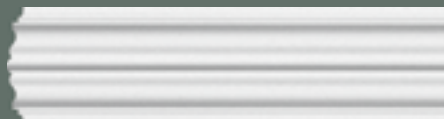

D 591 ©
2000x95x21 mm



D 587
254x95x40 mm



D 593
95x95x25 mm



D 589
115x154x16 mm



D 584
135x235x30 mm



D 600
110x110x28 mm



D 585
135x325x16 mm



D 586
80x140x16 mm

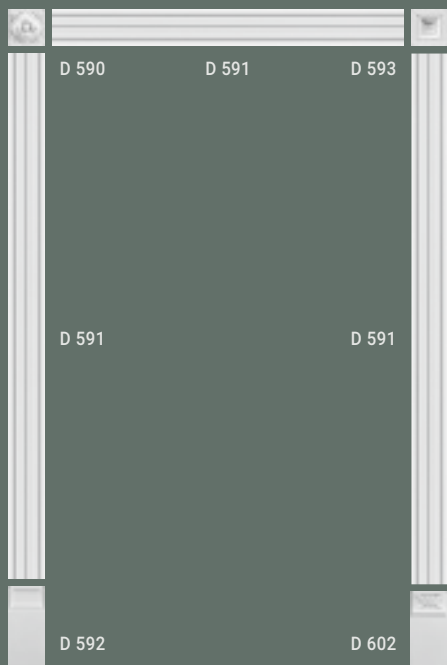



РОЗЕТКИ ПОТОЛОЧНЫЕ

Традиционно потолочные розетки составляют центральную часть композиции потолка и оформляют пространство вокруг люстры. Сегодня некоторые дизайнеры используют их в качестве орнамента на потолке или стене. Вместе с подобранными молдингами и карнизами придают потолку законченный вид.





R 4015

Ø 200 mm H 40 mm



R 316

Ø 300 mm H 35 mm



R 314

315x600 mm H 45 mm



R 4016

Ø 300 mm H 32 mm



R 318

Ø 335 mm H 45 mm



R 312

Ø 400 mm H 32 mm



R 4017

Ø 400 mm H 36 mm



R 4032

Ø 400 mm H 42 mm



R 303

Ø 415 mm H 45 mm



R 4025

Ø 430 mm H 22 mm



R 311

Ø 435 mm H 44 mm



R 349

Ø 460 mm H 36 mm



R 4012

Ø 475 mm H 48 mm



R 313

Ø 482 mm H 35 mm



R 309

Ø 495 mm H 58 mm



R 4022

Ø 500 mm H 55 mm



R 310

Ø 515 mm H 32 mm



R 4029

Ø 520 mm H 35 mm



R 4019
500x800 mm H 31 mm



R 345
Ø 525 mm H 29 mm



R 317
Ø 560 mm H 55 mm



R 348
Ø 575 mm H 27 mm



R 4039
Ø 596 mm Ø внутр. 100 mm H 48 mm



R 306

Ø 600 mm H 46 mm



R 4023

Ø 600 mm H 31 mm



R 301

Ø 600 mm H 71 mm



R 4006

Ø 665 mm H 65 mm



R 336

Ø 667 mm H 20 mm



R 337

Ø 670 mm H 55 mm



R 4024

Ø 720 mm H 61 mm



R 335

Ø 738 mm H 49 mm



R 308

Ø 760 mm H 45 mm



R 120

Ø 770 mm H 41 mm



R 307

Ø 830 mm H 52 mm



пример окрашивания



R 302
Ø 968 mm H 79 mm



R 4007
Ø 1010 mm H 65 mm



R 361
730x1080 mm H 25 mm



КЕССОНЫ

Это квадратные или многоугольные углубления на потолке или внутренней поверхности арки, свода или потолка, играют конструктивную роль, а также применяются для улучшения акустики помещений. Кессоны монтируются в подвесной гипсокартонный потолок и используются группой.





R 4041
609x609x73 mm



R 4009
604x604x40 mm



R 4043
609x609x84 mm



R 4042
609x609x73 mm



R 4046
612x612x78 mm

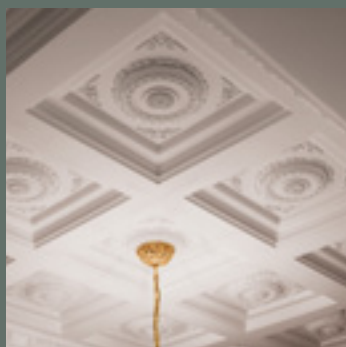

пример



ПИЛЯСТРЫ

Пилястры предназначены для вертикального разделения плоскости на функциональные зоны. Могут использоваться парами в обрамлении дверей. При помощи пилястр можно избавиться от скучного, однообразного вида стены.

E — общая высота в сборе

Капитель	PL 551	PL 559L/R PL 554	PL 563	PL 564 PL 565 PL 566	PL 564 PL 565 PL 567	PL 557
Тело	PL 550	PL 553	PL 573	PL 575	PL 576	PL 553x2
База	PL 552	PL 555	PL 574	PL 566	PL 566	PL 555x2



PL 557
345x419x95 mm



PL 551
163x178x45 mm



PL 554
145x225x50 mm



PL 559L/R
191x216x65 mm



PL 550
2000x110x20 mm



PL 553
2000x135x20 mm



PL 553
2000x135x20 mm



PL 553 x2 шт.
2000x135x20 mm



PL 552
255x110x30 mm



PL 555
255x135x30 mm



PL 555
255x135x30 mm



PL 555 x2 шт.
255x135x30 mm

E 2418 mm

E 2400 mm

E 2446 mm

E 2600 mm



PL 563

80x260x70 mm

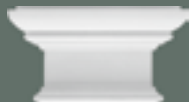

PL 565

170x318x77 mm



PL 564

170x313x77 mm



PL 567

212x212x30 mm



PL 573

2000x165x18 mm



PL 575

2200x197x20 mm



PL 576

2000x197x20 mm



PL 576

2000x197x20 mm

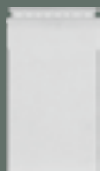

PL 574

355x195x30 mm



PL 566

640x288x60 mm



PL 566

640x288x60 mm



PL 566

640x288x60 mm

E 2435 mm

E 3010 mm

E 2810 mm

E 2852 mm



КОЛОННЫ

Е — общая высота в сборе

Колонны используются как опорный элемент карниза, для оформления входа в здание или помещение. Могут быть применены в арочных конструкциях или проемах. Внутри помещения отделяют проходную часть от гостиной. Колонна состоит из капители, тела колонны и базы. Длину тела колонны можно варьировать в зависимости от высоты помещения путем укорачивания или дотачивания необходимой части.



КАПИТЕЛЬ



Диаметр	Ширина	Высота	● Full (F)	◐ Half (H)
Ø 120 mm	228	155	L 9312 F	L 9322 H
Ø 150 mm	290	207	L 9314 F	L 9324 H
Ø 180 mm	330	245	L 9316 F	L 9326 H
Ø 200 mm	375	257	L 9318 F	L 9328 H

ТЕЛО



КАПИТЕЛЬ



Диаметр	Ширина	Высота	● Full (F)	◐ Half (H)
Ø 120 mm	230	85	L 9311 F	L 9321 H
Ø 150 mm	265	105	L 9313 F	L 9323 H
Ø 180 mm	300	115	L 9315 F	L 9325 H
Ø 200 mm	360	125	L 9317 F	L 9327 H

БАЗА



Диаметр	Ширина	Высота	● Full (F)	◐ Half (H)
Ø 120 mm	200	100	L 9309 F	L 9309 H
Ø 150 mm	240	130	L 9310 F	L 9310 H
Ø 180 mm	280	145	L 9319 F	L 9319 H
Ø 200 mm	310	160	L 9320 F	L 9320 H

Диаметр	Рифленое	Гладкое
Ø 120 mm	L 9301 F/H	L 9302 F/H
Ø 150 mm	L 9303 F/H	L 9304 F/H
Ø 180 mm	L 9305 F/H	L 9306 F/H
Ø 200 mm	L 9307 F/H	L 9308 F/H
Высота, мм	2395	2425

КОМБИНАЦИЯ С КОЛОННОЙ Ø 120 mm

КОМБИНАЦИЯ С КОЛОННОЙ Ø 150 mm

L 9311 F
L 9321 H
85x230 mm

L 9312 F
L 9322 H
155x228 mm

L 9313 F
L 9323 H
105x265 mm

L 9314 F
L 9324 H
207x290 mm



L 9301 F/H
2395 mm



Ø внеш.:
120 mm

Ø внут.:
70 mm

L 9303 F/H
2395 mm



Ø внеш.:
150 mm

Ø внут.:
75 mm

L 9302 F/H
2425 mm



Ø внеш.:
120 mm

Ø внут.:
70 mm

L 9304 F/H
2425 mm



Ø внеш.:
150 mm

Ø внут.:
75 mm

L 9309 F/H
100x200 mm

L 9309 F/H
100x200 mm

L 9310 F/H
130x240 mm

L 9310 F/H
130x240 mm

КОМБИНАЦИЯ С КОЛОННОЙ Ø 180 mm

КОМБИНАЦИЯ С КОЛОННОЙ Ø 200 mm

L 9315 F
L 9325 H
115x300 mm

L 9316 F
L 9326 H
245x330 mm

L 9317 F
L 9327 H
125x360 mm

L 9318 F
L 9328 H
257x375 mm



L 9305 F/H
2395 mm



Ø внеш.:
180 mm

Ø внут.:
105 mm

L 9307 F/H
2395 mm



Ø внеш.:
200 mm

Ø внут.:
125 mm

L 9306 F/H
2425 mm



Ø внеш.:
180 mm

Ø внут.:
105 mm

L 9308 F/H
2425 mm



Ø внеш.:
200 mm

Ø внут.:
125 mm

L 9319 F/H
145x280 mm

L 9319 F/H
145x280 mm

L 9320 F/H
160x310 mm

L 9320 F/H
160x310 mm



L 901 ○
300×355 mm



L 911 ○
2000 mm
Ø внеш.: 225 mm
Ø внут.: 205 mm



L 921 ○
120×325 mm

E: 2420 mm



L 902 ○
140×345 mm



L 912 ○
2000 mm
Ø внеш.: 225 mm
Ø внут.: 215 mm



L 921 ○
120×325 mm

E: 2250 mm



L 903 ○
300×370 mm



L 912 ○
2000 mm
Ø внеш.: 225 mm
Ø внут.: 215 mm



L 921 ○
120×325 mm

E: 2420 mm

ПЬЕДЕСТАЛЫ

Пьедестал — это укороченная колонна с художественно оформленным основанием, на котором устанавливают различные произведения искусства — статуи, скульптурные группы, бюсты, вазы, обелиски, стелы и других декоративных деталей интерьера.

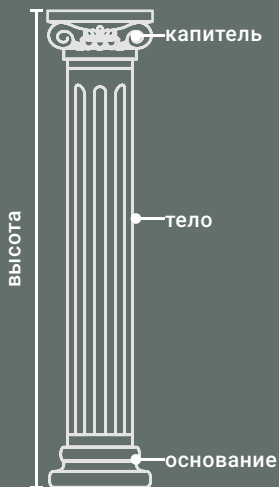

L 924 ○

Высота: 790 mm
Капитель: 350 mm
Ø тела: 220 mm
Основание: 300 mm

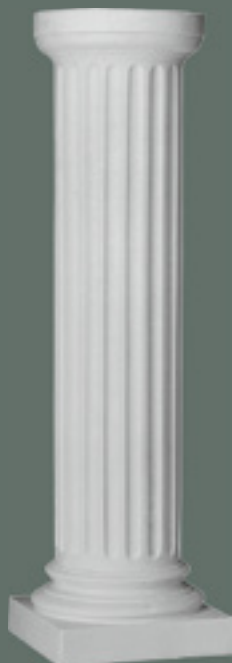

L 904 ○

Высота: 1050 mm
Капитель: 310 mm
Ø тела: 220 mm
Основание: 322 mm

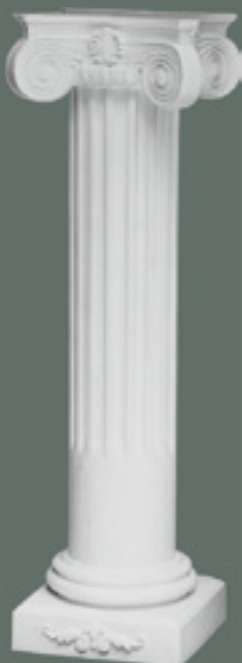

L 914 ○

Высота: 1117 mm
Капитель: 330 mm
Ø тела: 220 mm
Основание: 310 mm



L 915 ○

Высота: 908 mm
Капитель: 250 mm
Ø тела: 120 mm
Основание: 250 mm



НИШИ

Ниши используются как встроенный элемент декора наружной и внутренней части дома. Пространство внутри ниши может быть заполнено бюстами, статуэтками, цветочными композициями, а также подсвечено.

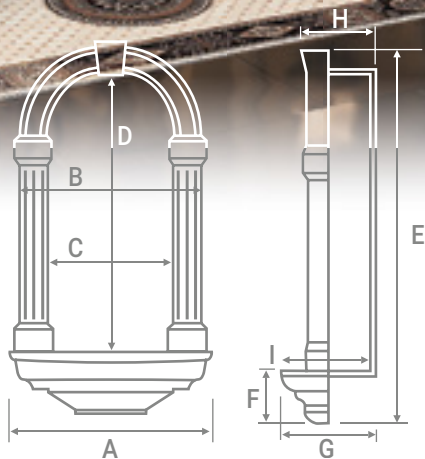



N 733 ◯

A: 420 mm
B: 375 mm
C: 265 mm
D: 560 mm
E: 765 mm
F: 135 mm
G: 105 mm
H: 30 mm



N 733-A ◯

A: 420 mm
B: 375 mm
C: 265 mm
D: 560 mm
E: 765 mm
F: 135 mm
G: 200 mm
H: 125 mm
I: 190 mm



КУПОЛА

Потолочные купола разработаны для преобразования потолка, придавая приятную иллюзию глубины и объема. Изготовлены из уплотненного полиуретана и пластика.

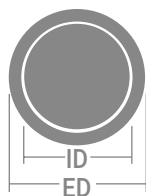



DM 3512 ○

ED: 2020 mm ID: 1760 mm D: 190 mm



DM 3503

ED: 720 mm ID: 570 mm D: 125 mm



DM 3504

ED: 1130 mm ID: 995 mm D: 215 mm



DM 3502 ○

ED: 1230 mm ID: 1080 mm D: 200 mm

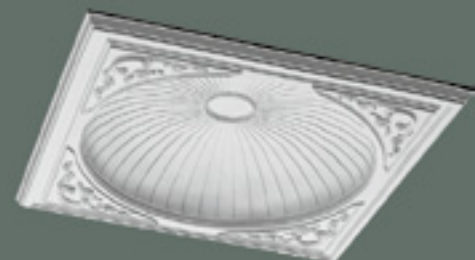

DM 3501 ○

ED: 1230 mm ID: 980 mm D: 230 mm



DM 3507 ○

ED: 1168 mm ID: 1005 mm D: 238 mm



КОНСОЛИ

Консоли обычно используют для увеличения привлекательности колонн и потолочных участков. С их помощью завершают дизайнерское оформление на основе иллюзии дерева, гранита. Возможно также использование консолей в качестве полок и опор.

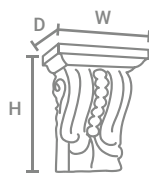

HxWxD

H — высота
W — ширина
D — глубина



B 824
109x88x43 mm



B 972
128x73x35 mm



B 821
140x115x70 mm



B 823
141x101x65 mm



B 822
143x107x70 mm



B 827M
152x100x54 mm



B 964
168x114x70 mm



B 960
189x116x85 mm



B 966
191x185x98 mm



B 965
200x72x65 mm



B 957
212x120x47 mm



B 835
220x130x94 mm



B 976
238x88x58 mm



B 962
250x168x122 mm



B 959
253x127x51 mm



B 815
269x156x55 mm



B 961
281x246x199 mm



B 977
310x130x75 mm



ОРНАМЕНТЫ

Многие дизайнеры используют разнообразные комбинации этих украшений для создания богатых, наполненных жизнью интерьеров. Ощутите удивительную разницу, используя не-много воображения.





A 620
Ø 60x10 mm



A 373
Ø 63x10 mm



A 621
65x65x8 mm



A 320
Ø 80x13 mm



A 328
89x89x12 mm



A 118
95x80x40 mm



A 319
Ø 95x15 mm



A 324
100x100x20 mm



A 322
Ø 155x30 mm



A 372
Ø 160x16 mm



A 321
Ø 165x25 mm



A 370
Ø 225x38 mm



AW 6018L/R
170x50x14 mm



AW 6039L/R
124x95x13 mm



AW 6027L/R
125x80x13 mm



AW 6051
225x570x30 mm



AW 6074L/R
295x135x16 mm



AW 6111L/R
260x126x15 mm



AW 6077
80x52x15 mm



AW 6020L/R
125x40x9 mm



AW 6071
67x215x15 mm



AW 6012
73x296x14 mm



AW 6063
120x615x15 mm



W 8036
320x910x50 mm



W 8023L/R
332x80x23 mm



W 8034
225x828x42 mm



W 8005
81x62x10 mm



W 8022
360x795x50 mm



W 8044
Ø 195 mm



W 804
738x525x35 mm



W 988
130x126x18 mm



W 8035
190x609x55 mm



W 8039
180x165x35 mm



W 8027
175x353x52 mm



W 706
270x425x20 mm



W 8029
225x416x52 mm



W 8029S
160x270x35 mm



W 8019
230x387x35 mm



W 703
220x410x35 mm

W 8037
190x165x35 mm



W 8038L/R
165x298x30 mm



W 8040
320x280x40 mm



W 8041L/R
287x686x47 mm



W 708
185x240x25 mm

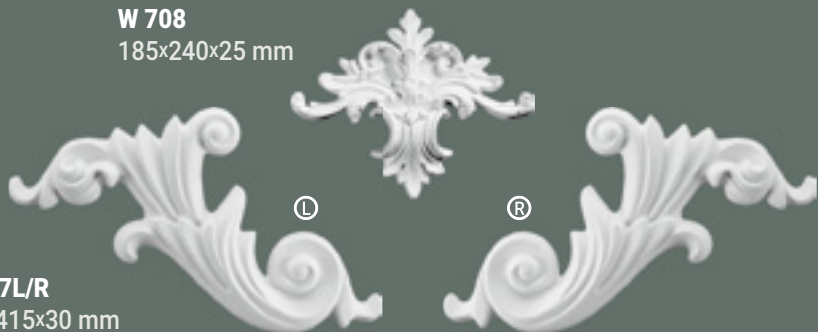

W 707L/R
190x415x30 mm



W 8025
125x550x37 mm



W 705
80x300x12 mm





W 8026S
140x230x30 mm



W 8021
155x290x25 mm



W 983
180x200x14 mm



W 984
160x117x30 mm



W 985
176x155x26 mm



M 901
внешний размер:
780x1000x39 mm
внутренний размер:
420x650 mm

1 B C D 3 E
A G 2 I J
4 F 5 H 6 7 K L
M N O P Q 8
S 9 T V W R
U X Z 0



A B C D E F
199x200 168x200 173x207 173x207 148x200 137x200

G H I J K L
187x207 160x200 40x200 128x204 174x200 140x198

M N O P Q R
195x203 159x200 194x206 153x200 194x224 179x200

S T U V W X
162x208 159x200 164x204 185x200 261x200 183x200

Y Z & ★ ♥ .
185x200 163x200 184x207 215x210 216x200 40x40

+ = 0 1 2 3
140x140 140x35 131x207 87x200 136x204 134x207

4 5 6 7 8 9
143x200 136x204 135x207 131x197 133x207 135x207



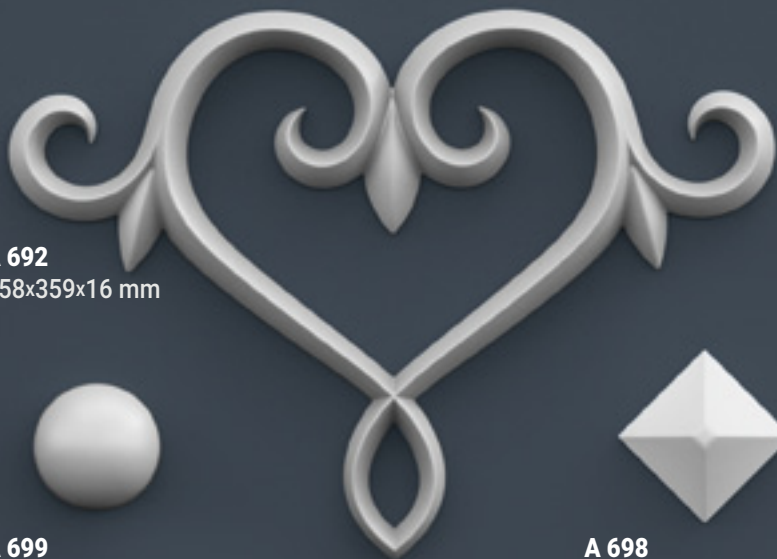

A 692
258x359x16 mm



A 699
50x50x21 mm



A 698
50x50x21 mm



A 697
99x49x21 mm



A 695
145x58x21 mm

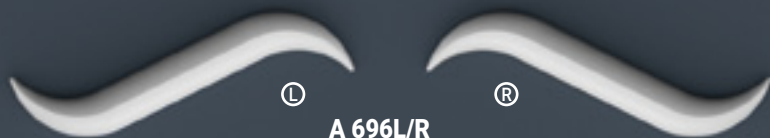

A 696L/R
138x64x11 mm

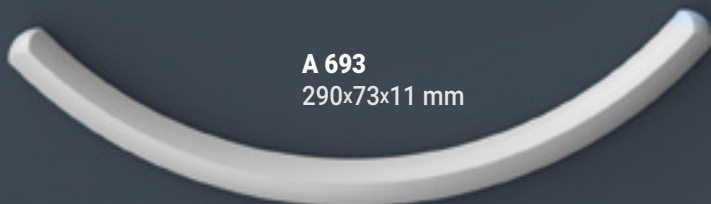

A 693
290x73x11 mm

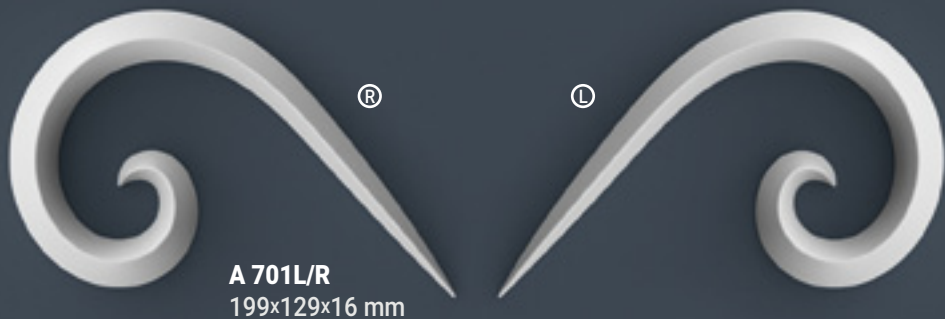

A 701L/R
199x129x16 mm



A 694L/R
209x111x11 mm

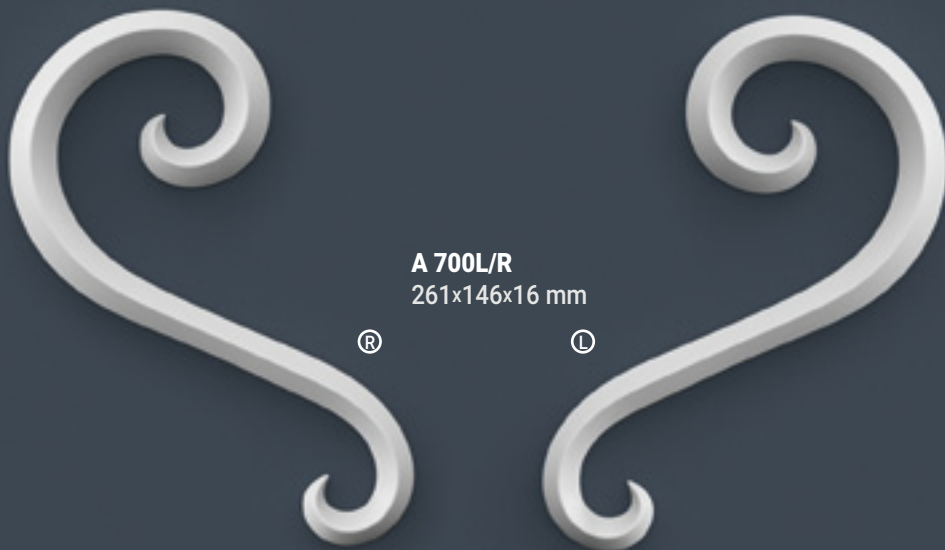

A 700L/R
261x146x16 mm



A 702
14x14x15 mm



A 704
60x24x12 mm



A 705
115x47x15 mm



A 703
25x25x20 mm



A 706
79x79x12 mm



A 707
151x151x15 mm



A 708
90x90x12 mm



A 713
125x125x12 mm



A 712
162x162x12 mm



A 709
180x180x15 mm



A 710
100x100x25 mm



A 711
145x145x35 mm



A 714
225x225x15 mm



A 715
330x330x15 mm

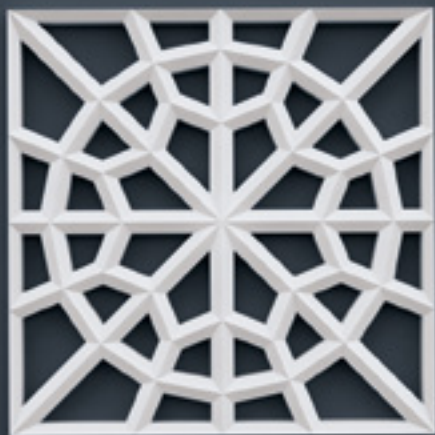

A 717
330x330x20 mm



A 716
330x330x20 mm



ОГЛАВЛЕНИЕ

Карнизы с гладким профилем	P 2016 (F)	6	C 1009	11	CR 3245 (F) ● 18	CF 602A	27
P 132	P 2024	8	C 1010 (F)	11	CR 3246 (F) ● 18	CF 605A	27
P 133 (F)	P 2031	8	C 1012 (F)	13	CR 3247 (F) ● 18	CF 605B	27
P 134 (F)	P 2032 (F)	7	C 1013 (F)	11		CF 607B	27
P 135 (F)	P 2048 (F)	7	C 1015 (F)	12	Молдинги	CF 611	25
P 136 (F)	P 2055 (F)	6	C 1030	11	с орнаментом	CF 612	25
P 149	P 2056 (F)	5	C 1035	12	CR 137 (F)	CF 613	25
P 201 (F)	P 2057 (F)	3	C 1049	13	CR 153	CF 614	25
P 202 (F)	P 2072 (F)	7	C 1061	14	CR 155	CF 620A	27
P 203 (F)	P 2076 (F)	6	C 1071 (F)	12	CR 402 (F)	CF 624A	26
P 205 (F)	P 2119 (F) ●	3	C 1085	10	CR 403 (F)	CF 624B	26
P 207 (F)			C 1088 (F)	12	CR 405 (F)	CF 3007A	26
P 208 (F)	Карнизы		C 1090 (F)	10	CR 407 (F)	CF 3007B	26
P 210 (F)	с орнаментом		C 1091	9	CR 601	CF 3010A	25
P 212 (F)	C 101	14	C 1092	9	CR 602 (F)	CF 3010B	25
P 214 (F)	C 102	14	C 1093 (F)	9	CR 605 (F)	CF 3010D	25
P 219 (F)	C 104 (F)	12	C 1097	12	CR 607 (F)	CF 3010E	25
P 220 (F)	C 109	13			CR 608 (F)	CF 3010C	25
P 221 (F)	C 110	14	Молдинги с гладким профилем		CR 620 (F)	CF 3063A	26
P 222 (F)	C 121 (F)	13	CR 512 (F)	17	CR 622	CF 3063B	26
P 223 (F)	C 122 (F)	12	CR 516 (F)	17	CR 632 (F)	CF 3227A	26
P 224 (F)	C 123 (F)	13	CR 518 (F)	16	CR 636 (F)	CF 3227B	26
P 232 (F)	C 124	12	CR 518 (F)	16	CR 638		
P 880 (F)	C 125	12	CR 610 (F)	16	CR 642	Дверные бордюры	
P 881 (F)	C 126 (F)	14	CR 624 (F)	16	CR 646 (F)	D 580 (F)	29
P 882 (F)	C 127	14	CR 689 (F)	17	CR 681 (F)	D 581	29
P 883 (F)	C 128	10	CR 3001 (F)	17	CR 685 (F)	D 584	29
P 884 (F)	C 138	11	CR 3002 (F)	17	CR 686 (F)	D 585	29
P 885 (F)	C 140 (F)	14	CR 3003 (F)	16	CR 688 (F)	D 586	29
P 886 (F)	C 141	10	CR 3006 (F)	17	CR 694	D 587	29
P 887 (F)	C 143	13	CR 3007 (F)	17	CR 3010	D 588	29
P 888 (F)	C 144 (F)	11	CR 3025 (F)	16	CR 3017	D 589	29
P 889 (F)	C 147	10	CR 3034 (F)	16	CR 3022	D 590	29
P 890 (F) ◇	C 150	9	CR 3035 (F)	16	CR 3023	D 591 (F)	29
P 891 (F) ◇	C 156	9	CR 3063 (F)	16	CR 3027	D 592	29
P 892	C 158	13	CR 3072 (F)	17	CR 3051 (F)	D 593	29
P 893	C 159	13	CR 3073 (F)	17	CR 3057	D 600	29
P 2001 (F)	C 160 (F)	11	CR 3075 (F)	16	CR 3059	D 601	29
P 2003 (F)	C 161 (F)	10	CR 3079 (F)	17	CR 3100 (F)	D 602	29
P 2004 (F)	C 173 (F)	10	CR 3227 (F)	16			
P 2005 (F)	C 176 (F)	10			Круговые бордюры	Розетки	
P 2006 (F)	C 177	12	Молдинги-плинтусы		LR 689/60	потолочные	
P 2007 (F)	C 204	13	CR 199 (F) ● 18		LR 689/70	R 120	37
P 2008 (F)	C 233	13	CR 639 (F) ● 18		LR 3073/50	R 301	36
P 2009 (F)	C 1001 (F)	11	CR 3043 (F) ● 18		LR 3073/65	R 302	38
P 2010 (F)	C 1003 (F)	10	CR 3044 (F) ● 18			R 303	33
P 2011 (F)	C 1004 (F)	11	CR 3241 (F) ● 18		Угловые элементы	R 306	36
P 2012 (F)	C 1007 (F)	11	CR 3242 (F) ● 18		CF 518A	R 307	37
	C 1008	10	CR 3243 (F) ● 18		CF 518B	R 308	37

ОГЛАВЛЕНИЕ

R 309	34	PL 565	43	L 9323 Half	45	A 321	58	W 8039	61
R 310	34	PL 566	43	L 9324 Half	45	A 322	58	W 8040	62
R 311	33	PL 567	43	L 9325 Half	45	A 324	58	W 8041L/R	62
R 312	32	PL 573	43	L 9326 Half	45	A 328	58	W 8044	60
R 313	34	PL 574	43	L 9327 Half	45	A 370	58		
R 314	32	PL 575	43	L 9328 Half	45	A 372	58	ART	
R 316	32	PL 576	43			A 373	58	Буквы	65
R 317	35			Пьедесталы		A 620	58	A 692	66
R 318	32	Колонны		L 904 ○	49	A 621	58	A 693	66
R 335	37	L 901 ○	48	L 914 ○	49	AW 6012	59	A 694L/R	67
R 336	36	L 902 ○	48	L 915 ○	49	AW 6018L/R	59	A 695	66
R 337	36	L 903 ○	48	L 924 ○	49	AW 6020L/R	59	A 696L/R	66
R 345	35	L 911 ○	48			AW 6027L/R	59	A 697	66
R 348	35	L 912 ○	48	Ниши		AW 6039L/R	59	A 698	66
R 349	33	L 921 ○	48	N 733 ○	51	AW 6051	59	A 699	66
R 361	38	L 9301 Full	45	N 733-A ○	51	AW 6063	59	A 700L/R	67
R 4006	36	L 9301 Half	45			AW 6071	59	A 701L/R	67
R 4007	38	L 9302 Full	45	Купола		AW 6074L/R	59		
R 4012	34	L 9302 Half	45	DM 3501 ○	53	AW 6077	59	ARXAT	
R 4015	32	L 9303 Full	45	DM 3502 ○	53	AW 6111L/R	59	A 702	68
R 4016	32	L 9303 Half	45	DM 3503	53			A 703	68
R 4017	33	L 9304 Full	45	DM 3504	53	Настенные		A 704	68
R 4019	35	L 9304 Half	45	DM 3507 ○	53	панно		A 705	68
R 4022	34	L 9305 Full	45	DM 3512 ○	53	M 901	63	A 706	68
R 4023	36	L 9305 Half	45			W 703	61	A 707	68
R 4024	37	L 9306 Full	45	Консоли		W 705	62	A 708	68
R 4025	33	L 9306 Half	45	B 815	56	W 706	61	A 709	68
R 4029	34	L 9307 Full	45	B 821	55	W 707L/R	62	A 710	68
R 4032	33	L 9307 Half	45	B 822	55	W 708	62	A 711	68
R 4039	35	L 9308 Full	45	B 823	55	W 804	60	A 712	68
		L 9308 Half	45	B 824	55	W 983	63	A 713	68
		L 9309 Full	45	B 827M	55	W 984	63	A 714	69
Кессоны		L 9309 Half	45	B 835	56	W 985	63	A 715	69
R 4009	40	L 9310 Full	45	B 957	56	W 988	60	A 716	69
R 4041	40	L 9310 Half	45	B 959	56	W 8005	60	A 717	69
R 4042	40	L 9311 Full	45	B 960	55	W 8019	61		
R 4043	40	L 9312 Full	45	B 961	56	W 8021	63		
R 4046	40	L 9313 Full	45	B 962	56	W 8022	60		
		L 9314 Full	45	B 964	55	W 8023L/R	60		
Пилястры		L 9315 Full	45	B 965	56	W 8025	62	Условные	
PL 550	42	L 9316 Full	45	B 966	55	W 8026S	63	обозначения:	
PL 551	42	L 9317 Full	45	B 972	55	W 8027	61	Ⓣ	имеется гибкий аналог
PL 552	42	L 9318 Full	45	B 976	56	W 8029	61	◇	шторные карнизы
PL 553	42	L 9318 Full	45	B 977	56	W 8029S	61	●	используется как плинтус
PL 554	42	L 9319 Full	45			W 8034	60	○	изделие из стекловолокна
PL 555	42	L 9319 Half	45			W 8035	61	LED	для встроенной подсветки
PL 557	42	L 9320 Full	45	Орнаменты		W 8036	60		
PL 559L/R	42	L 9320 Half	45	A 118	58	W 8037	62		
PL 563	43	L 9321 Half	45	A 319	58	W 8038L/R	62		
PL 564	43	L 9322 Half	45	A 320	58				

ИНСТРУКЦИЯ ПО МОНТАЖУ ЛЕПНОГО ДЕКОРА



1 Сделайте отметки карандашом на стене, чтобы определить местоположение карниза.



2 Используя мелкозубчатую ножовку, вырезайте карниз под углом 45 градусов.



3 Нанесите клей вдоль по краям обратной стороны карниза, а также на поверхность, которую будете клеить.



4 Соедините оба карниза вместе, чтобы их профили совпали. Используйте специальный клей для стыковки изделий.



5 Перед тем как забить гвозди, убедитесь в ровности соединения.



6 С помощью ножика для заделки швов, обработайте стыки карнизов.



7 Для шлифовки поверхности используйте наждачную бумагу.



8 Закройте стены и потолок тепп-лентой. Используя кисточку, покройте краской карниз.

Перед установкой элементов лепнины необходимо, чтобы изделия были адаптированы к помещению. Для этого следует их оставить на 24 часа в данном помещении. Предварительно следует убедиться, что стены и потолок в местах монтажа лепнины сухие и чистые, для более надежной склейки их с полиуретаном.



